

UM10390

HF-TL ballast with UBA2021 for TLD58W Lamp

Rev. 01 — 11 October 2009

User manual

Document information

| Info | Content |
|-----------------|--|
| Keywords | UBA2021, HF-TL ballast, TLD58W Lamp |
| Abstract | A low cost electronic TL ballast has been designed, which is able to drive a Philips TLD58W lamp or similar. |

Revision history

| Rev | Date | Description |
|-----|----------|---|
| 01 | 20091011 | First issue replaces application note AN98099 |

Contact information

For more information, please visit: <http://www.nxp.com>

For sales office addresses, please send an email to: salesaddresses@nxp.com

1. Introduction

A low cost electronic TL ballast has been designed, which is able to drive a Philips TLD58W lamp or similar.

A voltage fed half bridge inverter has been chosen as lamp driver circuit. The inverter has been designed for a nominal input voltage of 230 V (RMS) and 50 Hz to 60 Hz. The key component in this circuit is the UBA2021 Integrated Circuit (IC) intended to drive and control a Compact Fluorescent Lamp (CFL) and/or Tubular Lamp (TL). The UBA2021 is a high voltage driver IC, which provides all the necessary functions for a correct preheat, ignition, and burn-state operation of the lamp. The UBA2021 also provides the level shift and drive circuit (high-side driver and bootstrap function included) for the two discrete power MOSFETs PHX3N50E and incorporates a capacitive mode protection.

The key issues for this design are low cost and low component count. The UBA2021 has a few peripheral components. Only a minimum amount of components are required for the optimal balance between maximum design flexibility and low component count.

2. Circuit and system description

2.1 Block diagram

The TL ballast has been designed for a nominal mains voltage of 230 V (RMS), 50 Hz to 60 Hz. The ballast operates within a mains voltage range of 185 V (RMS) to 265 V (RMS) and the mains voltage performance range is limited to 200 V (RMS) to 260 V (RMS). Basically, the circuit consists of three sections, an EMI filter, an AC bridge rectifier, and the half bridge inverter. [Figure 1](#) shows the block diagram of the circuit. The complete schematic diagram is given in [Figure 3](#).

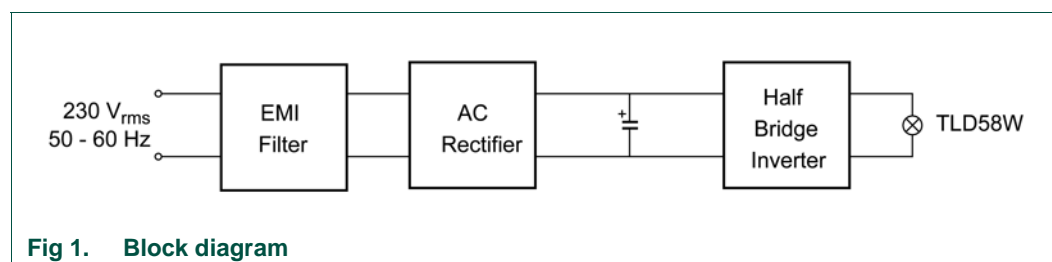

The AC mains voltage is rectified by four bridge rectifying diodes. The DC supply voltage for the half bridge inverter is smoothed by a buffer capacitor. An EMI filter is used to minimize the disturbance to the mains. The half bridge inverter is of the voltage fed type belonging to a group of high frequency resonant inverters, which are very good for driving lamp circuits. They can achieve a high efficiency because of the zero voltage switching principle. This reduces the switching losses of the two power MOSFETs.

2.2 Half bridge inverter

For a reliable system operation and long lamp maintenance, the fluorescent lamp is preheated first after switch on. This is called "warm start". This preheat current is controlled by the UBA2021, see [Figure 2](#) for the functional diagram. The electrode current meets the requirements to obtain a proper electrode emitter temperature.

Proper preheating results in a smooth ignition of the lamp at a much lower ignition voltage with less component and/or electrical stress.

The circuit is designed so that a feed forward control regulates the lamp power. The result is an almost constant level of light output over a large mains voltage range.

2.3 Start-up phase

After switch-on of the system, the rectified mains voltage is applied to the buffer capacitor C4 via inrush limiter R1. The buffer capacitor smooths the ripple voltage caused by the (doubled) mains frequency. The result is a high DC voltage V_{hv} , which is an input for the half bridge inverter (power components: TR1, TR2, L1, C7, the lamp, C5, and C6).

During the start-up phase, the low voltage supply capacitors C9, C10, and C13 are charged out of the high DC voltage via resistors R2, R4, a lamp electrode, and pin 13 of the UBA2021. Pin 13 is internally connected to pin 5 during the start-up phase (start-up supply path). As soon as the supply voltage V_s across C13 reaches 5.5 V, the UBA2021 resets. After this initial reset, MOSFET TR2 is set conductive and MOSFET TR1 to non-conductive. This allows the bootstrap capacitor C12 to be charged via the UBA2021 internal bootstrap function. The supply voltage V_s increases and the circuit starts oscillating when $V_s > 12$ V. The IC supply current is internally clamped up to currents of 14 mA. The system now enters the preheat phase.

Remark: The system provides automatic protection against starting up while no lamp is connected. The start-up supply path is interrupted by the absence of the electrode (see [Section 2.7](#)).

2.4 Preheat phase

The MOSFETs TR1 and TR2 are brought in conduction alternately. This introduces a square-wave voltage, V_{hb} , across the half bridge midpoint between zero and V_{hv} . The start frequency is 98 kHz. Under these conditions the circuit formed by D5, D6, and C8 through C10 is able to take over the low voltage supply function from the start-up supply path.

For a time period of approximately 1.8 s (preheat time, t_{ph}), defined by capacitor C17 and R7, the system stays in the preheat operating point where the lamp electrode current is controlled. This allows both lamp electrodes to heat up in a defined, optimal way. The electrode emitters are warmed up and large quantities of electrons are emitted into the lamp. Ignition of the lamp can now take place at a much lower ignition voltage so that the electrical stress applied to the circuit and the lamp is minimal. This defined electrode preheat followed by a smooth ignition is very important to obtain a good maintenance of the lamp.

After the start of oscillation, a small AC current starts floating from the half bridge midpoint through L1, C7, and the lamp electrodes. The frequency now gradually decreases and the AC current increases. The slope of decrease in frequency is determined by the value of capacitor C14 and an internal current source. The frequency decrease stops when a defined value of the AC voltage across the preheat sense resistors R5 and R6 is reached, approximately 3 ms after switch-on. The UBA2021 now controls the AC current through the lamp electrodes by measuring the voltage drop across R5 and R6. This control point is called preheat operating point. [Figure 5](#), [Figure 6](#), [Figure 7](#), and [Figure 8](#) show some oscillograms of this controlled preheat.

During the whole preheat phase, the half bridge frequency is well above the resonance frequency of L1 and C7 (55.6 kHz), so the voltage across C7 is low enough to keep the lamp from igniting. It is very important to keep the voltage across C7 well below the non-ignition value of the lamp. Otherwise, the lamp ignites too early which causes blackening of the lamp ends. This phenomenon is called "cold ignition".

The value of the ballast coil L1 is determined by the required lamp current, the igniter capacitance C7, and the operating frequency in the burn phase. The value for the minimum igniter capacitance C7 is determined by L1 and the non-ignition voltage of the lamp at a given preheat current and a minimum mains voltage. The result is that an igniter capacitor $C7 = 8.2 \text{ nF}$ gives the best preheat performance.

2.5 Ignition phase

After the preheat time has expired, the UBA2021 further decreases the switching frequency of the half bridge down to the bottom frequency f_b (39 kHz). Now the rate of the decrease in frequency is much slower than it was in the preheat phase. The switching frequency moves towards the resonance frequency of the series circuit formed by L1, C7, and the lamp electrodes (55.6 kHz), where the impedance of the DC blocking capacitors C5 and C6 are proposed to be rather small.

The worst case ignition voltage¹ of the TLD58W lamp is about 600 V (pk) for low temperatures. The combination of ballast coil L1 and igniter capacitor C7 has been chosen in such a way that the voltage across the lamp can exceed this high level. The ignition voltage of the lamp determines the maximum value of C7 at a given L1 due to the bottom frequency, f_b , of the UBA2021. The bottom frequency is set by R7 and C15/C16. The maximum available ignition time t_{ign} is 1.7 s (15/16 part of t_{ph}) set by C17 and R7.

Assuming the lamp has ignited during the downwards frequency sweep, the frequency decreases to the bottom frequency, f_b . The UBA2021 can make the transition to burn phase in two ways:

- If f_b is not reached, the transition is made after the maximum available ignition time, t_{ign}
- when f_b is reached

2.6 Burn phase

In the burn phase the circuit normally drops down to f_b (39 kHz) which can be used as the nominal operating frequency. However, the circuit is designed to use the feed forward control of the UBA2021 so that the frequency is dependent on the current through the RHV pin (pin 13). The feed forward control becomes active after reaching f_b .

During the start-up phase the low voltage supply capacitors C9, C10, and C13 are charged by the high DC voltage V_{hv} , via the resistors R2, R4, the lamp electrode, and pin 13 of the UBA2021. Pin 13 is internally connected to pin 5. In the burn phase previous interconnection is replaced by another connection, pin 13 to pin 8. Now the current through R2 and R4 is used as feed forward information to control the switching frequency of the half bridge and is proportional to the amplitude of the rectified mains voltage V_{hv} .

1. When both the luminaire and the circuit are connected to the mains protection earth.

The ripple on V_{hv} (100 Hz to 120 Hz) is filtered by C17. The effect is that the lamp power stays more or less the same over an input mains voltage range of 200 V (RMS) to 260 V (RMS) (see [Table 3](#)).

The lamp can be seen as a resistive load for frequencies above 10 kHz. The lamp efficiency of a TL lamp driven at a frequency above 10 kHz increases considerably compared to a 50 Hz to 60 Hz driven lamp. This means that a TLD58W powered with 50 W HF gives the same light output as a TLD58W lamp powered with 58 W at 50 Hz to 60 Hz. The steady state operating point of a TLD58W lamp is given by a lamp voltage of 110 V (RMS) and a lamp current of 455 mA RMS) resulting in a lamp power of 50 W.

The value of the ballast coil L1 is determined by the lamp operating point, the igniter capacitance C7, and the operating frequency which is approximately 45 kHz at a nominal input of 230 V (RMS).

It can be calculated that for the actual values of L1, C7, and the TLD58W lamp, the total circuit delivers the desired lamp power. However, other L1/C7 combinations are also possible. Parameters like the preheat operating point, the minimum required ignition voltage, and component tolerances determine which combination suits best. The result is that an inductance of L1 = 1 mH as ballast coil and igniter capacitor C7 = 8.2 nF give the best overall performance.

2.7 Protections

A capacitive mode protection has been implemented in the UBA2021 IC to protect the power circuit against excessive electrical stress. This protection will become active during the ignition phase and the burn phase. Therefore the UBA2021 checks the zero voltage switching condition each half bridge switching cycle. This is done by monitoring the voltage across R5 and R6. If this voltage is below 20 mV (typical) at the time of turn-on of TR2, capacitive mode operation is assumed.

As long as this capacitive mode is detected, the UBA2021 IC increases the switching frequency. The rate of frequency increase is much faster than the rate of decrease during the preheat phase and the ignition phase. Finally, the switching frequency will be above the resonance frequency. If no capacitive mode is detected, the frequency drops down again to the feed forward frequency.

A lamp removal protection is incorporated by means of the low voltage supply for the UBA2021. When lamp removal takes place, the AC voltage on C6 is zero so that the low voltage supply for the UBA2021 is cut off. The circuit starts up when the lamp is replaced without switching off the ballast.

Finally, the circuit will not start up when the lamp is not present. In this situation, the start-up resistor R4 is cut off from V_{hv} .

2.8 Power components

The used electrolytic capacitor C4 is of the ASH-ELB 043 series, especially designed for electronic lamp ballasts, with a useful life time of 15.000 hours at 85 °C and a high ripple current capability.

The applied MOSFETs, TR1 and TR2, are of the type PHX3N50E². Due to the Zero Voltage Switching (ZVS) principle, the switching losses of the two power MOSFETs are reduced to a minimum. The power losses are merely conduction losses that heat up the devices that are dependent on their thermal resistance, R_{th} , and drain-source resistance R_{Dson} . The duration of the preheat phase and the ignition phase is rather small so that the choice of the MOSFET type is determined by the ballast coil current in the burn phase. The PHX3N50E is supplied in the SOT186A full pack, isolated package. The PHX3N50E characteristics are: $V_{DSS} = 500$ V and $R_{Dson} < 3$ W. All together the PHX3N50E suits best in this application.

The ballast coil, L1, of 1 mH is designed to withstand ignition peak currents of up to 2.5 A so that a system without protection earth can be used. The used coil is an E25/13/7 -core with 3C85 as core material.

The ignition capacitor, C7, of 8.2 nF is of the KP/MMKP 376 type designed for applications where high dV/dt with a high repetition rate is desired. The applied capacitor withstands peak-to-peak voltages of up to 1700 V (600 V (RMS) sine wave).

2.9 UBA2021

2.9.1 General

The control component is the UBA2021 IC. This is a high voltage IC intended to drive and control a Compact Fluorescent Lamp (CFL) and/or Tubular Lamp (TL). The UBA2021 contains a driver circuit with integrated high-side drive and bootstrap function, an oscillator, and a control and timer circuit for starting up, preheating, ignition, lamp burning, and capacitive mode protection. The maximum voltage applied to the IC is 390 V and for short transients ($t < 0.5$ s) 570 V. The low voltage supply is internally clamped so that an external zener diode is not needed. The current clamp capability is 14 mA and for short transients ($t < 0.5$ s) 35 mA. The UBA2021 is available in the DIP14 package and the SO14 package.

[Figure 2](#) shows the functional diagram of the UBA2021.

2. The suffix "E" means that the MOSFET is a repetitive ruggedness rated device.

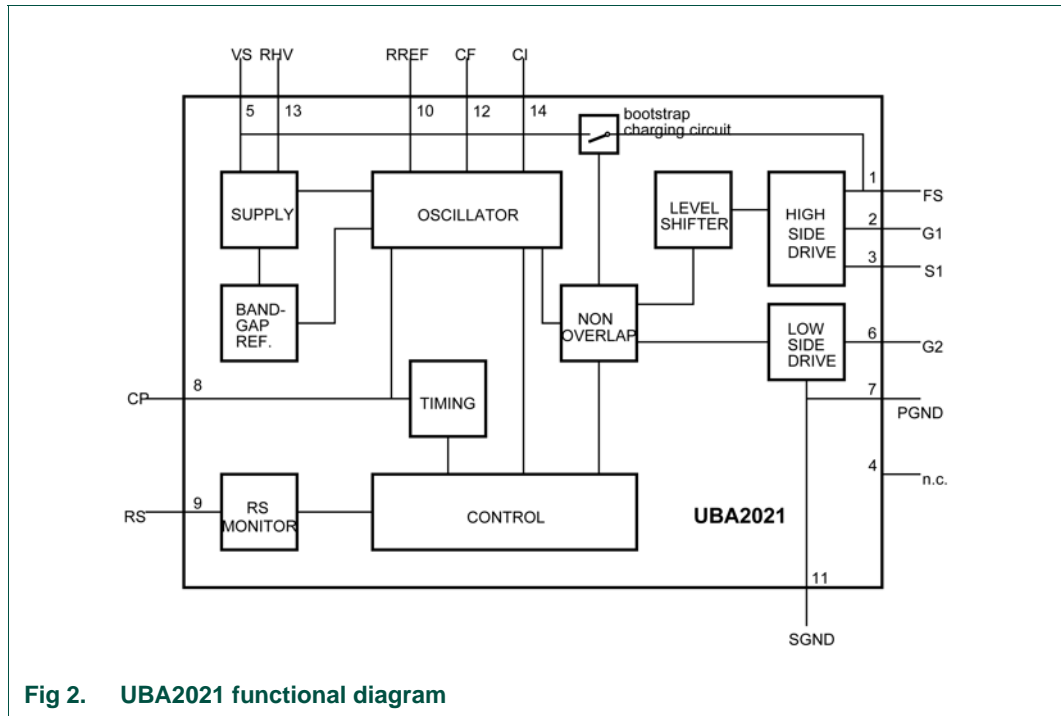

Fig 2. UBA2021 functional diagram

2.9.2 Design equations UBA2021

Equation 1, Equation 2, Equation 3, Equation 4, Equation 5, and Equation 6 give the design calculations for the UBA2021. The typical UBA2021 parameters³ are listed in Table 1.

Table 1. UBA2021 typical parameters

| | |
|---------------------------------|------------------------------|
| $X_1 = 3.68$ | $R_{int} = 3\text{ k}\Omega$ |
| $X_2 = 22.28$ | $C_{par} = 4.7\text{ pF}$ |
| $\tau = 0.4\text{ }\mu\text{s}$ | $V_{ref} = 2.5\text{ V}$ |

The bottom frequency, f_b , is set by R_{ref} and C_f . In the circuit diagram $R_{ref} = R7$ and $C_f = C15/C16$.

$$f_b = \frac{I}{2 \cdot [(C_f + C_{par}) \cdot (X_1 \cdot R_{ref} - R_{int}) + \tau]} \tag{1}$$

The feed forward frequency f_{ff} depends on the current through the RHV pin, I_{RHV} . Equation 2 calculates the feed forward frequency f_{ff} which holds for the interval $0.5\text{ mA} \leq I_{RHV} \leq 1\text{ mA}$. The frequency is clamped for currents out of range.

$$f_{ff} = \frac{I}{2 \cdot [(C_f + C_{par}) \cdot (X_2 \cdot \frac{V_{ref}}{I_{RHV}} - R_{int}) + \tau]} \tag{2}$$

The preheat time t_{ph} is set by R_{ref} and C_p . In the circuit diagram is $R_{ref} = R7$ and $C_p = C17$.

3. The UBA2021 data sheet gives a detailed description.

$$t_{ph} = \frac{C_p}{150 \times 10^{-9}} \cdot \frac{R_{ref}}{30 \times 10^3} \quad (3)$$

The ignition time t_{ign} is a factor of t_{pre} .

$$t_{ign} = \frac{15}{16} \cdot t_{ph} \quad (4)$$

The non-overlap time t_{no} is given by [Equation 5](#) ($R_{ref} = R7$).

$$t_{no} = 1.4 \times 10^{-6} \cdot \frac{R_{ref}}{30 \times 10^3} \quad (5)$$

The operating frequency, f_{oper} , is the maximum value of f_b , f_{ff} , and f_{cm} , where f_{cm} is the frequency due to the capacitive mode operation.

$$f_{oper} = \max(f_b, f_{ff}, f_{cm}) \quad (6)$$

3. HF-TL BALLAST PCB

The 58 W TL ballast with UBA2021 is designed on printed-circuit board using leaded components. In this chapter the schematic diagram, layout, and parts list are given.

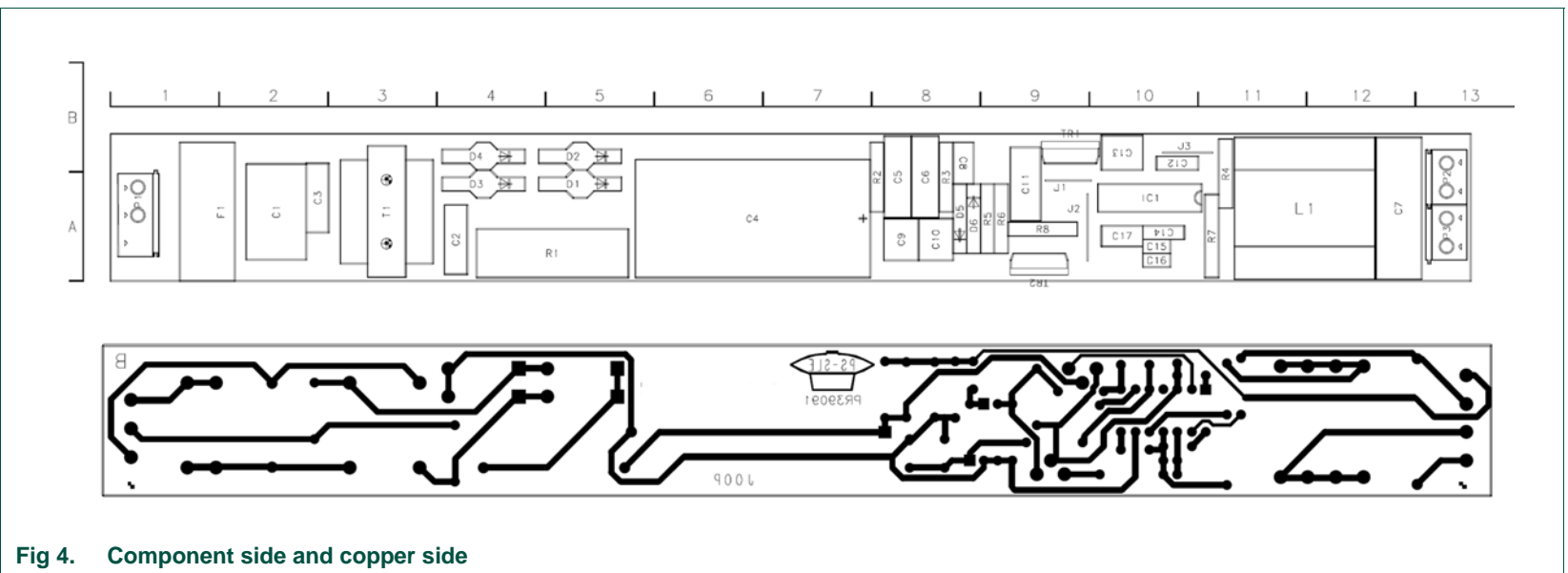

Fig 4. Component side and copper side

3.2 Layout ballast

3.3 Bill of materials ballast

Table 2. Bill of materials ballast

| Part | Value | Rating | Type | 12 no. code |
|--------------|-----------------|--------|-------------------|----------------------|
| C1 | 220 nF | 275 V | MKP 336 2 | 2222-336-20224 |
| C2, C3 | 2.2 nF | 250 V | MKP 336 6 | 2222-336-60222 |
| C4 | 33 μ F | 450 V | ASH 043 | 2222-043-91339 |
| C5, C6 | 47 nF | 250 V | MKP 379 | 2222-379-44473 |
| C7 | 8.2 nF | 2000 V | KP/MMKP 376 | 2222-376-92822 |
| C8 | 15 nF | 250 V | MKT 370 | 2222-370-35153 |
| C9, C10, C13 | 1 μ F | 63 V | MKT 370 | 2222-370-75105 |
| C11 | 1 nF | 630 V | KT 347 | 2222-347-61102 |
| C12, C14 | 100 nF | 63 V | MKT 370 | 2222-370-75104 |
| C15 | 10 pF | 100 V | Class I; 2 %; NPO | 2222-680-10109 |
| C16 | 100 pF | 100 V | Class I; 2 %; NPO | 2222-680-10101 |
| C17 | 270 nF | 63 V | MKT 370 | 2222-370-75274 |
| R1 | 4.7 Ω | - | AC04 | 2322-329-04478 |
| R2, R4 | 220 k Ω | 350 V | SFR25H | 2322-186-16224 |
| R3 | 470 k Ω | 350 V | SFR25H | 2322-186-16474 |
| R5, R6 | 1.2 Ω | 350 V | SFR25H | 2322-186-16128 |
| R7 | 30.1 k Ω | 350 V | MRS25 | 2322-156-13013 |
| L1 | 1 mH | - | EF25/13/7 | 8228-001-32932 |
| T1 | 27 mH | - | CU15d3/1 | 3112-338-31712 |
| IC1 | UBA2021 | - | SOT27 | available on request |
| D1 to D4 | BYW54 | - | SOD57 | 9333-636-10153 |
| D5, D6 | 1N4148 | - | SOD27 (DO-35) | 9330-839-90153 |
| TR1, TR2 | PHX3N50E | - | SOT186A | 9340-550-03127 |
| F1 | 1 A Slow | - | | |

4. Performance

4.1 Oscillograms

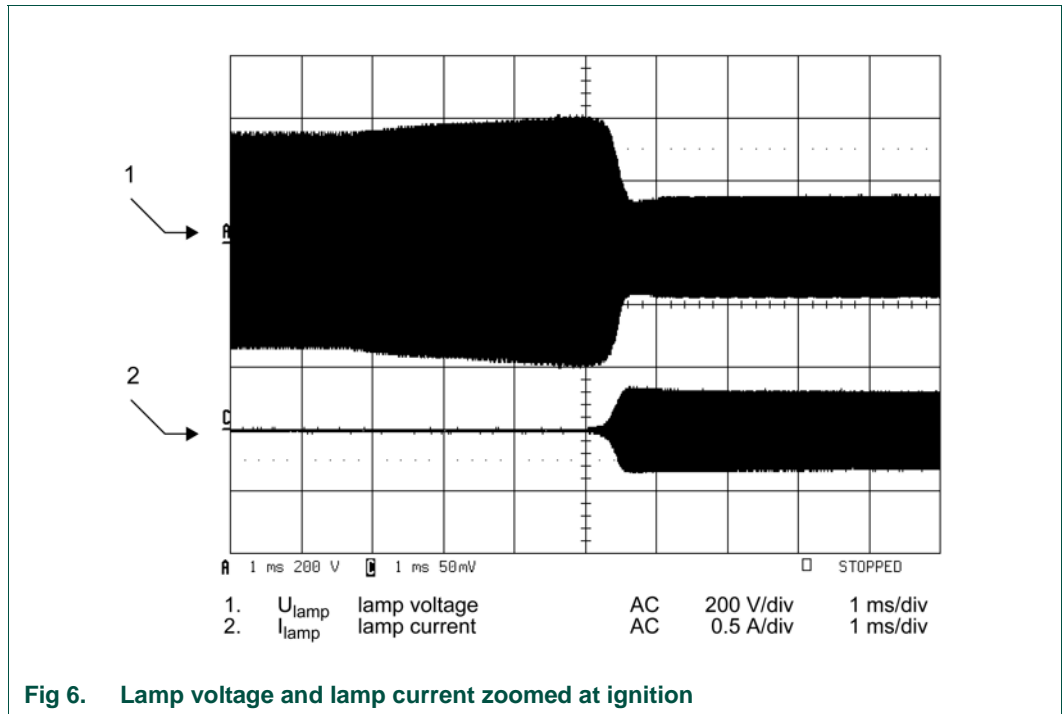
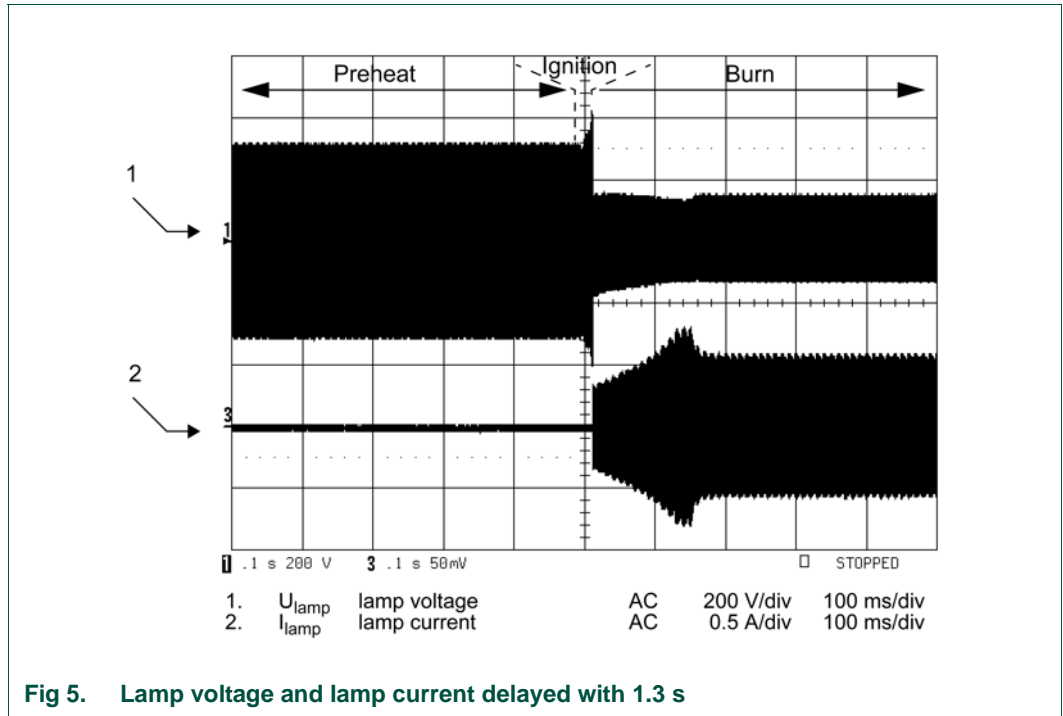

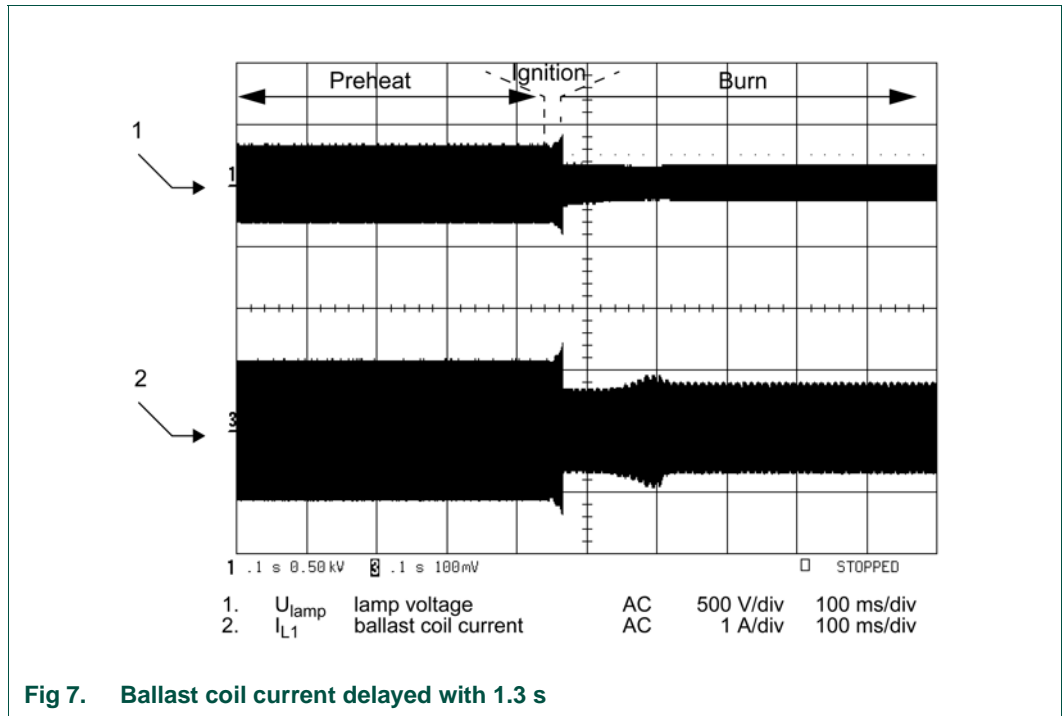

Fig 7. Ballast coil current delayed with 1.3 s

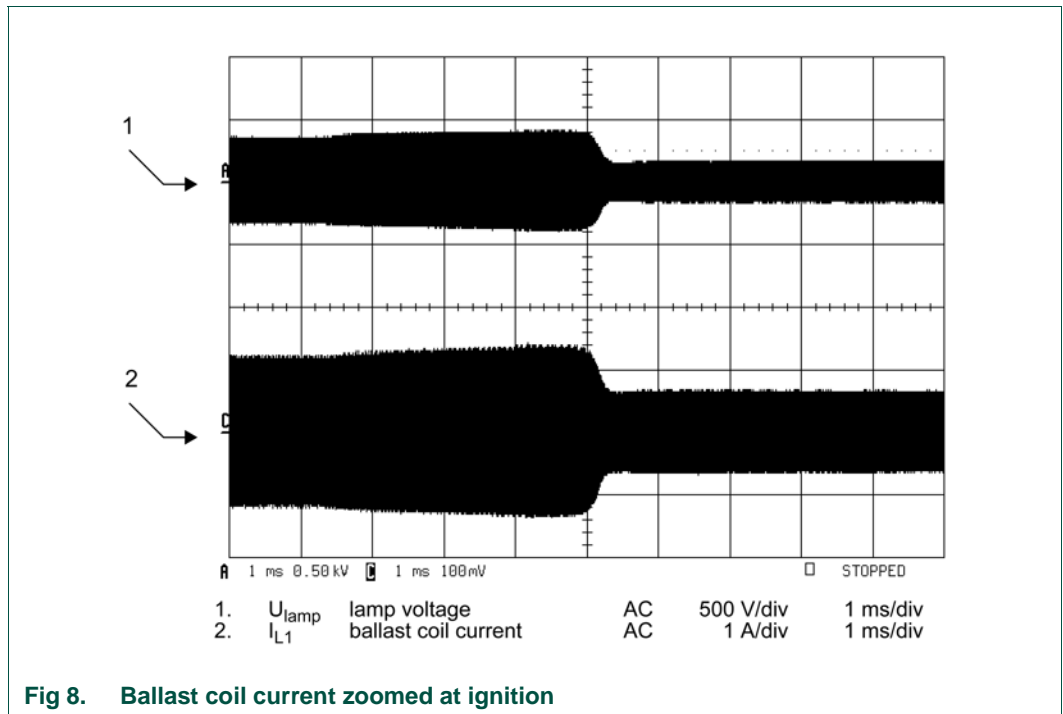

Fig 8. Ballast coil current zoomed at ignition

4.2 Ballast performance

Table 3. Ballast performance

| V_{mains} (V) | P_{mains} (W) | P_{lamp} (W) | η (%) |
|------------------------|------------------------|-----------------------|------------|
| 200 | 52.0 | 47.6 | 92 |
| 210 | 53.5 | 48.9 | 91 |
| 220 | 54.4 | 49.6 | 91 |
| 230 | 55.0 | 50.0 | 91 |
| 240 | 55.4 | 50.2 | 91 |
| 250 | 55.6 | 50.3 | 91 |
| 260 | 55.8 | 50.3 | 90 |

5. Legal information

5.1 Definitions

Draft — The document is a draft version only. The content is still under internal review and subject to formal approval, which may result in modifications or additions. NXP Semiconductors does not give any representations or warranties as to the accuracy or completeness of information included herein and shall have no liability for the consequences of use of such information.

5.2 Disclaimers

General — Information in this document is believed to be accurate and reliable. However, NXP Semiconductors does not give any representations or warranties, expressed or implied, as to the accuracy or completeness of such information and shall have no liability for the consequences of use of such information.

Right to make changes — NXP Semiconductors reserves the right to make changes to information published in this document, including without limitation specifications and product descriptions, at any time and without notice. This document supersedes and replaces all information supplied prior to the publication hereof.

Suitability for use — NXP Semiconductors products are not designed, authorized or warranted to be suitable for use in medical, military, aircraft, space or life support equipment, nor in applications where failure or malfunction of a NXP Semiconductors product can reasonably be expected to result in personal injury, death or severe property or environmental damage. NXP Semiconductors accepts no liability for inclusion and/or use of NXP Semiconductors products in such equipment or applications and therefore such inclusion and/or use is at the customer's own risk.

Applications — Applications that are described herein for any of these products are for illustrative purposes only. NXP Semiconductors makes no representation or warranty that such applications will be suitable for the specified use without further testing or modification.

Export control — This document as well as the item(s) described herein may be subject to export control regulations. Export might require a prior authorization from national authorities.

5.3 Trademarks

Notice: All referenced brands, product names, service names and trademarks are the property of their respective owners.

6. Contents

| | | |
|----------|---|-----------|
| 1 | Introduction | 3 |
| 2 | Circuit and system description | 3 |
| 2.1 | Block diagram | 3 |
| 2.2 | Half bridge inverter | 3 |
| 2.3 | Start-up phase | 4 |
| 2.4 | Preheat phase | 4 |
| 2.5 | Ignition phase | 5 |
| 2.6 | Burn phase | 5 |
| 2.7 | Protections | 6 |
| 2.8 | Power components | 7 |
| 2.9 | UBA2021 | 7 |
| 2.9.1 | General | 7 |
| 2.9.2 | Design equations UBA2021 | 8 |
| 3 | HF-TL BALLAST PCB | 9 |
| 3.1 | Schematic diagram ballast | 10 |
| 3.2 | Layout ballast | 11 |
| 3.3 | Bill of materials ballast | 12 |
| 4 | Performance | 13 |
| 4.1 | Oscillograms | 13 |
| 4.2 | Ballast performance | 15 |
| 5 | Legal information | 16 |
| 5.1 | Definitions | 16 |
| 5.2 | Disclaimers | 16 |
| 5.3 | Trademarks | 16 |
| 6 | Contents | 17 |

Please be aware that important notices concerning this document and the product(s) described herein, have been included in section 'Legal information'.



© NXP B.V. 2009.

All rights reserved.

For more information, please visit: <http://www.nxp.com>

For sales office addresses, please send an email to: salesaddresses@nxp.com

Date of release: 11 October 2009

Document identifier: UM10390_1